

AAL Programme - "SAVE"

AAL Programme



AAL-CP-2018-5-149-SAVE

01/09/2019 - 31/08/2022

Table of Contents

1. Overview on general User Requirements	3
2. Services Concepts	6
2.1. Solution-Neutral Function	6
2.2. Services Concepts Proposals and Scenario of Use	7
2.3. Trade-off analysis	16
3. Services Definition and Main Architectures	18
3.1. Services Definitions	18
3.2. Services Modeling	20
3.3. Integrated services architecture	30
References	33

AAL Programme - "SAVE"

1. Overview on general User Requirements

In order to define general requirements on elderly people (according to SAVE project proposal), the approach in this respect is based on:

- i. general objectives of the AAL Programme¹:
 - improving and increasing the elder's autonomy, self-confidence and mobility in their preferred environment;
 - maintaining and supporting of health and functional capabilities of the elders;
 - supporting a healthier lifestyle of the elders;
 - preventing social isolation and security enhancing of the elders;
 - supporting the elder's families and care organisations.
- ii. a general picture of chronic diseases associated with aging (as in Figure 1²);

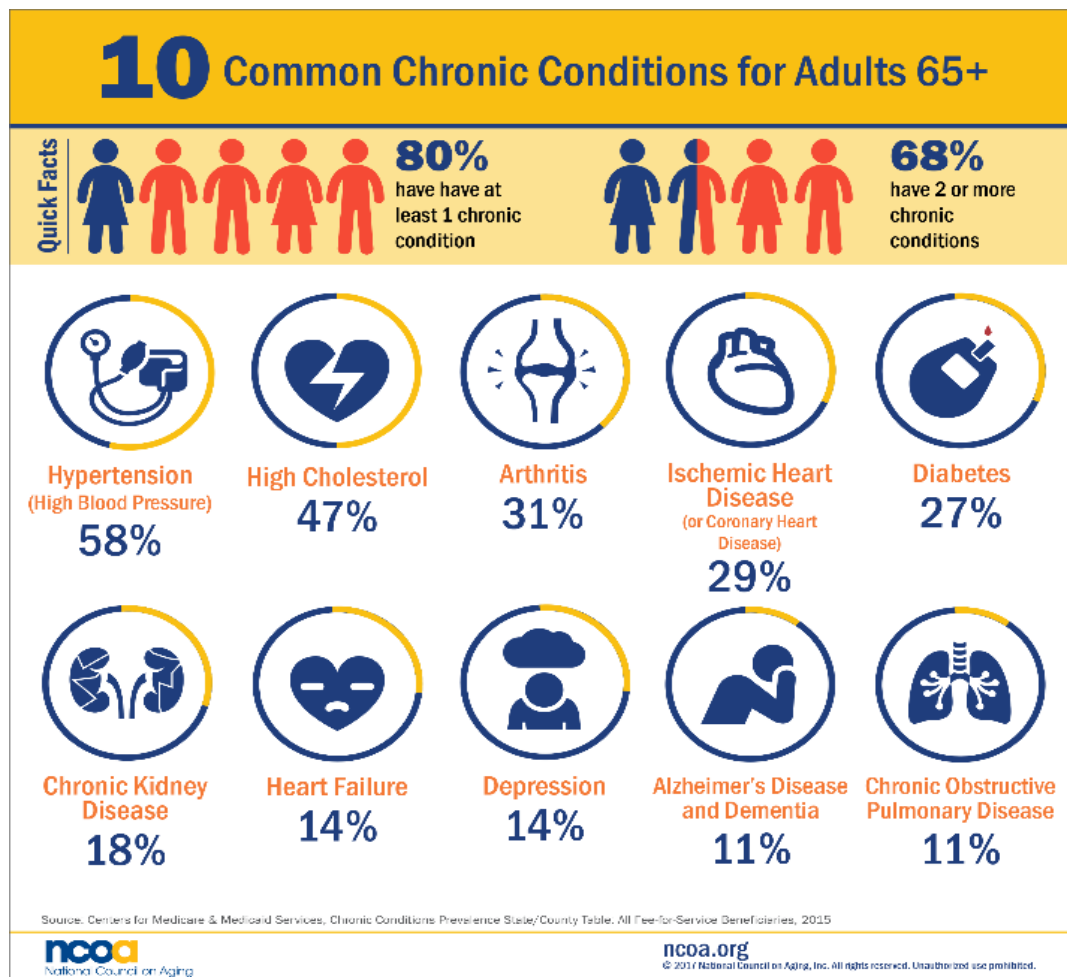

Figure 1. 10 common chronic conditions for adults 65+

¹ <http://www.aal-europe.eu/about/>

² <https://www.ncoa.org/blog/10-common-chronic-diseases-prevention-tips/>

AAL Programme - "SAVE"

- iii. the general scenario assumed in the SAVE project proposal,

The general scenario assumed in the SAVE project proposal, reiterated herein;

“Armand is a 67 years old man. Armand feels often lonely and spends much time at home watching TV. He started gaining some weight, and suffers from high blood pressure and prostatic hypertrophy. One day, he participates in the “Technology Club” within the social assistance service of the municipality, next to two other friends. Mihai is 69 years old and suffers from mild dementia and Beatrice, 66 years old, is suffering from a physical disability. They were engaged in a training course, held by the SAVE project team: they were shown how to use simple technology devices (e.g. wearable bracelets) to assess their fitness, how to make their home activities more safe (e.g. prevention of house fire), how to use intelligent furniture for safety (e.g. avoid falling) how to keep in touch with fellow groups and with local social and health authorities (e.g. with smartphones and tablets). At the course, they were given a few devices sponsored by the municipality (e.g. sensors kits), in order to test them at their home and while walking. At this course they all started also to learn how to use the location systems that will help them to come back safely to their home. During these sessions, supervised by the volunteers, they also completed behavior questionnaires (personalised, for safety and ethical reasons). Then, Armand, Mihai and Beatrice installed the SAVE demo app on their smartphone and registered for SAVE services. Through the “To Do” section of the app, they will be also notified about next activities, synchronised in the “Personal cloud” of their relatives, friends and formal caregivers. In this group Armand also designated some “reference persons” (namely, Beatrice and his son Charlie) who may be informed in case of troubles and may provide further information if needed. One day, Armand was going to the market and suddenly didn’t remember where he was living, where his house was. He invoked the SAVE system that noticed Armand is 2.5 km from home. He pushed the safety button and the application started to show him the road back to his house. Arriving home, he realised that he was very tired and fell while trying to start the heating in the house. The app “Ping” interactive capability, suspecting another problem, prompted Armand with some signals - “emoticons”. Armand managed to push the Emergency button and the system alerted the authorities automatically (including the localisation info), asking for help. After this experience and talking with the doctors and his friends he realised that his physical condition is very low (with problems of balance, of legs or hands coordination). He decided to apply for the full SAVE service suite and smartphone apps, enrolling also to start physical exercises for improving well-being - either at the club or at home, with the support from volunteering organisations”.

General User Prerequisites for adopting a value-oriented approach.

The inclusion criteria, as expressed through project proposal, shall consider elders aged 65 year or older, feeling physically and cognitively fit, able of self-assessment, sufficiently mobile, capable of maintaining, changing their position, manipulating and moving objects, moving in their place of residence, living environment, moving around using transportation. In this respect, certain User Prerequisites (UP) have been defined in the table below.

AAL Programme - "SAVE"

User Prerequisite (UP)	Traceability
UP1. The user shall be aged 65 years or older.	Project Proposal
UP2. The user shall live alone.	Project Proposal
UP3. The user shall own a smartphone.	Project Proposal
UP4. The user shall be able to handle small objects.	Project Proposal
UP5. The user shall be able to use a smartphone.	Project Proposal
UP6. The user shall not Suffer from severe chronic illness or severe disability.	Project Proposal
UP7. The user shall have mobile internet access on his/her site.	Project Proposal
UP8. The user shall manage tasks and demands suggested by caregivers/volunteers.	Project Proposal
UP9. The user shall be able to learn and apply knowledge.	Project Proposal
UP10. The user shall manage self-care tasks suggested by caregivers/volunteers.	Project Proposal
UP11. The user shall manage basic daily activities.	Project Proposal
UP12. The user shall be able to walk by foot.	Project Proposal
UP13. The user shall be able to manage enrolments into local social care services in terms of physical exercises and social gatherings.	Project Proposal
UP14. The user shall manage interpersonal relations.	Project Proposal
UP15. The user shall engage in community and social life.	Project Proposal
UP16. The user shall be able to perform relaxing/moderate physical exercise.	Project Proposal

AAL Programme - "SAVE"

2. Services Concepts

2.1. Solution-Neutral Function

The Solution Neutral Function presents the spectrum of functions that SAVE project proposal envisaged without specifying the solution.



Figure 2. Overview in Solution Neutral Function. Source SAVE Project Proposal.

The rationale of SAVE is the re-orientation in a supportive environment for the end-user in terms of position – location (e.g. showing the way home or the way to the community center closest to the actual position) and/or in terms of safety (e.g. in a sensor-equipped intelligent kitchen) but also in a broader cognitive and behavioral sense that is interpersonal and task-oriented. In such a general perspective, the role of the caregiver starts with the help for “reintegration” of

AAL Programme - "SAVE"

those in need in their "personal cloud" (e.g. retrieving the... forgotten goals in the shared “to do” group objectives), enhancing safety (both of the person and of his/her vicinity).

SAVE is aiming to living independently and safely for longer time at home (using a sensors kit for activity monitoring and safety assessment), and autonomously outside home (using locating systems for guidance back home or to the nearest point of support) with involvement in physical activities (a pro-active extension of the reorientation effort, monitored by wearable devices) with the goal of health improvement and social insertion/integration.

2.2.Services Concepts Proposals and Scenario of Use

Based on the Solution Neutral Function, there are generated the Services Concepts as a large repertory of solutions that may satisfy the general user requirements already stated in the section 1 of the current document.

In the following section, there is presented the repertory of services concepts along with proper scenarios of use:

Table 1. Location and identification concept	
Title	1. Location and identification service
Description (120-200 words, 6-10 rows)	<p>Guidance-navigation and tracking, a modification of the “search and advertise” state-of-the art LBS (Location-Based Services) that are using GIS (Geographical Information Systems) combined with the graphical capabilities of the smartphone. Customizable “advertising” should be re-oriented on elderly support POI (Points Of Interest) configured with home / relatives’ houses / ... / community centers / local clinic facilities. Google technologies are a very good reference (e.g. Maps combined with Assistant). Tracking info could be associated with personal ID & medical profile / medical history records.</p> <p><i>To be decided on the pro activeness of the approach (tracing, recording the usual routes, alerting of the caregivers in case of deviation, etc.)</i></p>
Target group (end users / institutions, elder people / caregivers / doctors, etc)	Elder people, professional caregivers, and companies for elderly people care.

AAL Programme - "SAVE"

Scenario of use (60-100 words, 3-5 rows)	One day, Armand was going to the market and suddenly didn't remember where he was living, where his house was. He invoked the SAVE system that noticed Armand is 2.5 km from home. He pushed the safety button and the application started to show him the road back to his house.
Involved devices	Smartphone, smartwatch, apps
Methods for assessment	Service operating verifying

Table 2. Subscribing Concept	
Title	2. Subscribing service
Description (120-200 words, 6-10 rows)	An extension of the subscription in the relationship with a mobile communications service provider: <ul style="list-style-type: none"> - Inspired by the HSS (Home Subscriber Service) of IMS (IP Multimedia Servers) based on a DB with user profiles – for AAA (Authentication, Authorization and Accounting) and medical reference. Such a solution is combined with the location and identity service (SLF - the subscriber location function of IMS).
Target group (end users / institutions, elder people / caregivers / doctors, etc)	end user - volunteer – institutional support staff (e.g. DSS Brasov) - caregiver - friends and family - medical assistant
Scenario of use (60-100 words, 3-5 rows)	Role-driven (the capabilities are growing from the end-user to the volunteer, to the family member, to professional caregiver and even to the IT specialist) but being approached as "concentric", in a unified way; enroll; access profile, rights, policies,
Involved devices	Smartphone / Laptop Internet connection
Methods for assessment	Service operation verifying

AAL Programme - "SAVE"

Table 3. Technology enabling and training Concept	
Title	3. Technology enabling & training
Description (120-200 words, 6-10 rows)	Training on simple technology devices - e.g. wearable bracelets that monitor the fitness or facilities that are making home activities more safe (preventing on of house fire), intelligent furniture. Training on communication with fellow groups and with local social and health authorities (e.g. with smartphones and tablets). Training on localization and routing.
Target group (end users / institutions, elder people / caregivers / doctors, etc)	Elder people, professional caregivers, companies for elderly people care.
Scenario of use (60-100 words, 3-5 rows)	At the course, the participants were given some devices sponsored by the municipality (e.g. sensors kits), in order to test them at their home and while walking. The participants started also to learn how to use the location systems that will help them to come back safely at their home. During these sessions, supervised by the volunteers, they also completed behavior questionnaires (personalised, for safety and ethical reasons). Installing and using the APPS
Involved devices	Sensors, smartphones, internet connection.
Methods for assessment	Team work, testing, practice activities

AAL Programme - "SAVE"

Table 4. Security Concept	
Title	4. Security services
Description (120-200 words, 6-10 rows)	<p>A unique system capable to perform:</p> <ul style="list-style-type: none"> - alerts (configuration of the alerts, training on accidents, firefighting, traffic rules), - technological training (smart mediation, electronic filtering-sorting, use of alerting means, alerting exercises, repetitions in alerting scenarios), - bilateral services (push – pull, alert and ping); <p>offering this way to both patient and medical doctor the possibility to track the medical history of the patient, storing automatically the clinical results into a cloud system. It can be launched either by the person, but in some cases (e.g. loss of consciousness) and should be launched automatically. In an emergency case it is important to permit asking for urgent help in a simple way.</p>
Target group (institutions, elder people / caregivers / doctors, etc.)	Institutions/ elder people / caregivers / doctors
Scenario of use (60-100 words, 3-5 rows)	<p>Safety of the person is integrated with the safety of the vicinity – compliant with the integrated (merged) emergency alerting (medical, police, fire etc.) available in many countries (SAVE aims to prove the concept of smart mediation to enhance alerts treatment and, on the other side, to discriminate real SOS from pre-filtered "spam" generated by people with cognitive problems or by malicious use-abuse) how to make their home activities more safe (e.g. prevention of house fire), how to use intelligent furniture for safety (e.g. avoid falling) how to keep in touch with fellow groups and with local social and health authorities (e.g. with smartphones and tablets). At the course, they were given a few devices sponsored by the municipality (e.g. sensors kits), in order to test them at their home and while walking. In the case of emergency (fall, collapse, injury etc.) should call for help in a very simple way, because is no time to look for the phone or dial 112.</p>
Involved devices	Sensors, smartphones, internet connection.
Methods for assessment	simulated or real emergency cases

AAL Programme - "SAVE"

Title	5. Enhancing alert info – personal/domotic alert service (“From whom can I ask for help” database/avatar)
Description (120-200 words, 6-10 rows)	<p>From this technological point of view, SAVE aims to contribute to the future of "Emergency calls" that should assist people at "both sides of the line" - not only end-users in need (that cannot open apps like Google Maps, not only because of cognitive impairment or lack of technical knowledge but even because of momentary extreme distress) but even volunteers or care-giving bodies operators that cannot interpret complex GIS (Geographical Information Systems) data. A simple "button to rule them all" can be pushed to alert those pre-configured "to assist" - e.g. family members, medical assistants, private security companies or even the police and the fire brigade - the specific is the personalization of this pre-alerting, with the sending of coordinates and a link to Google Maps that marks the location where this button was pushed. A pre-set personalized message (about the condition of the sender - e.g. epileptic) should be attached. All data should be integrated with virtual assistants (e.g. project DALIA: http://www.dalia-aal.eu/about/, ALFRED: https://alfred.eu/project/index.html)</p>
Target group (end users / institutions, elder people / caregivers / doctors, etc.)	<ul style="list-style-type: none"> - elder people - family members - medical assistants - private security companies - dispensary
Scenario of use (60-100 words, 3-5 rows)	<p>1. Armand pushed the safety button and the application started to show him the road back to his house. Arriving at home, he realized that he was very tired and fell while trying to start the heating in the house. The app "Ping" interactive capability, suspecting another problem, prompted Armand with some signals - "emoticons". He managed to push the Emergency button and the system alerted the authorities automatically (including the localization info), asking for help. After this experience and talking with the doctors and his friends he realized that his physical condition is very low (with problems of balance, of legs or hands coordination).</p> <p>2. Maria lives alone in an apartment in Tallin, Estonia. When she wakes up she does not find her glasses on the night shelf she believed to put it before falling asleep. Maria asks the Virtual Assistant on her Smart Bracelet for help. During the dialogue with Virtual Assistant the use of Maria's glasses was traced back to the fine details. Finally it was postulated that the glasses should be around the night shelf. The Virtual Assistant proposed Maria to look around the floor too. Maria was very happy to find her glasses on the carpet on the floor.</p>

AAL Programme - "SAVE"

Involved devices	smartphone, sensors, apps, internet connection
Methods for assessment	Tracking by the caregivers, and bench-mark test on the mutual understanding of the language, the easiness of the vocal communication situations

Table 6. Well-being Concept

Title	6. Adapting physical exercise and social activities for elderly people, driven by voluntary organizations, regarding stress/cognitive assessment services, actigraphy based services and virtual trainer			
Description (120-200 words, 6-10 rows)	<p>Physical exercises for elders with support from volunteers. Adults aged 65 or older who are generally fit and have no health conditions that limit their mobility should try to be active daily. Examples of activities that require moderate effort for most people include: walking, ballroom and dancing, pushing different objects, playing table tennis (single, double). Muscle strength is necessary for:</p> <ul style="list-style-type: none"> - all daily movement 	<p>Actigraphy based Services are remote solutions that use wearable devices monitoring human rest/activity cycles in order to enhance the well-being of a person. Usually, the services offer the option to store the data in a cloud for further offline assessments. Also, Actigraphy based Services gather additional information relevant for caregivers who take care of the elder people.</p>	<p>Stress/Cognitive assessment Services are remote solutions designed to enhance the well-being state of the person by offering suggestions in order to re-establish the balance between working and relaxing time. Stress Assessment Services evaluate specific changes of stress level and/or stress phase (excitement, stress and recovery) and usually store the data in a cloud for further offline assessments. Cognitive assessments tools evaluate cognitive</p>	<p>Virtual Trainer: To retain good physical condition and well-being, doing physical exercises is essential in all ages. Elder people often forget doing such exercises or they are simply not motivated to get moving. To change this, a virtual trainer regularly notifies the elder person to do some physical exercises which are shown by animations or videos on a display to conduct the user's movement. The actual series of exercises are customizable by family members, professional caregivers or even by the elderly</p>

AAL Programme - "SAVE"

	<p>- building and maintaining strong bones (improving their balance condition and their daily fit activities)</p> <p>- maintaining a healthy weight.</p>		<p>components decline, like alertness, attention, reduced stimulus perception and decision making.</p>	<p>person him/herself using the ASR/TTS interface. The virtual trainer can assess the performance of the user based on different sensors (wearable IMU sensors and/or depth camera e.g. Microsoft Kinect) and can provide performance analysis for caregivers and therapists to help them find the most appropriate exercises for their patient.</p>
<p>Target group (end users / institutions, elder people / caregivers / doctors, etc)</p>	<p>Target group: Elder people, family members, friends, professional caregivers, companies for elderly people care, Voluntary organizations who will be responsible for conducting these physical exercises.</p>			
<p>Scenario of use (60-100 words, 3-5 rows)</p>	<p>Armand decided to apply for the full SAVE service suite and smartphone apps, enrolling also to start physical exercises for improving well-being - either at the club or at home, with the support from volunteering organizations.</p>	<p>Actigraphy based Services provide to the elder a wearable tracker. The elder wears the tracker that analyses the rest/activity cycles. Using the embedded sensors, the tracker usually notifies the subject about the inactivity and recommends walk and/or other physical exercises during the day. The device also aims to</p>	<p>Stress Assessment Services provide to the elder a wearable stress-tracker. The elder wears the tracker that analyses the evolution of his/her stress level. The elder is advised to stop working, relax and/or breathe in order to diminish stress level and thus, to enhance</p>	<p>The elder lives alone in an apartment in Budapest, Hungary. When she wakes up, she feels pain at her hip, so she turns to the Virtual Trainer and asks for some exercises that can relieve the pain. The trainer shows her some simple hip exercises (bending forward-backward, then left and right) that she tries to</p>

AAL Programme - "SAVE"

		track the number of steps, heart rate, rest/sleep cycles and estimates the calories burned during the day.	its well-being state. Cognitive assessments will be operational in terms of Choice Reaction Time sensor based entertainment.	perform. In the meantime, the trainer analyses her performance based on sensor information from the depth camera and the IMU sensors of the smart bracelet on the elder's wrist. After the exercises are performed, the trainer shows a report on the elder's performance. Then this report, together with the elder's self-diagnosis about her hip pain are sent to her daughter and/or caregiver.
Involved devices	smartphone, sensors, apps, internet connection			
Methods for assessment	Muscle-strengthening exercises are counted in repetitions and sets. Involving in different physical programs two times in a week Subjective Quality of Life survey			

Table 7. To Do List Concept	
Title	7. Personal (re-) planning service - "TO DO List"
Description (120-200 words, 6-10 rows)	<p>Ensuring a configuration for memory refreshing - gathering the following activities in a list - to help the end-user to remember / update activities.</p> <p>The "To do list" will include:</p> <ul style="list-style-type: none"> - a section with "mandatory" actions - e.g. medication administration; it can be edited by the caregiver, and elderly people will confirm the fulfillment of the requirements, otherwise alerts will be issued to the elderly and caregivers

AAL Programme - "SAVE"

	<ul style="list-style-type: none"> - a section with recommended / optional actions - administrative activities, participation in various programming or occasional activities - a section with the intended activities – and update of the immediate schedule of the short- (and medium-) term activities <p>Data regarding the maintenance of physical and mental tonus can be generated.</p>
Target group (end users / institutions, elder people / caregivers / doctors, etc)	elderly people, caregivers, doctors
Scenario of use (60-100 words, 3-5 rows)	Through the “To Do” section of the app, they will be also notified about next activities, synchronised in the “Personal cloud” of their relatives, friends and formal caregivers. In this group Armand also designated some “reference persons” (namely, Beatrice and his son Charlie) who may be informed in case of troubles and may provide further information if needed.
Involved devices	smartphone, apps, internet connection
Methods for assessment	Subjective Quality of Life survey

Table 8. eHealth Concept		
Title	8. eHealth Monitoring Services	
Description (120-200 words, 6-10 rows)	<p>eHealth Monitoring Services in terms of Online Health Service (OnHS) are remote e-Health solutions based on eHealth devices integrated into a unique system capable to store automatically the biometric data results into a cloud system, offering this way to both user and caregiver/volunteer the possibility to track the biometric data evolution of the elder.</p>	<p>eHealth Monitoring Services in terms of Offline Health Service (OffHS), are related to the traditional comprehensive healthcare system.</p>
Target group	Elder people; Caregivers, volunteers; companies for elderly people care;	

AAL Programme - "SAVE"

	insurance companies, NGOs;	
Scenario of use (60-100 words, 3-5 rows)	eHealth Monitoring Services, in terms of OnHS, provide to the elder a system composed of several eHealth devices and offer a solution to pre-train the elder for proper use of each biometric sensor (i.e. by a caregiver and/or a volunteer). The elder measures periodically the physiological parameters of interest according to the recommendation of the caregiver. After the measurements are done, the data is online transmitted and stored in the cloud, and both elder and caregiver are able to track the biometric data evolution.	In this context, elders use commercial off the shelf eHealth devices, measure periodically their biometric parameters according to the recommendation of the corresponding caregiver. After the measurements are done, the parameters of interest are manually checked and recorded by the elders, and further transmitted to the corresponding caregiver within the planned visits.
Involved devices	eHealth devices	
Methods for assessment	The Services in each category available on the market will be assessed considering the project general requirements, end-user requirements, technological readiness level, ease of use, compatibility and price.	

2.3. Trade-off analysis

Trade-off method description.

One of the methods recommended in Systems Engineering (SE) theory for performing trade-off analysis among different product/service concepts or design solutions is the Pugh selection method or Pugh Concept Selection. The Pugh Concept Selection is a decision-matrix method enabling assessment of various service alternatives against a set of criteria.

As applied to SAVE context, via The Pugh Concept Selection method, it will be analyzed by the SAVE consortium developers potential service components categories for elders, and concluding with the identified service components validity considering the defined criteria: SAVE project budget, SAVE Project schedule, Technology Readiness Level; SAVE Project Proposal general guidelines and requirements.

Each criterion has a proposed weight (as detailed in the tables below), and each solution identified has a quantification with respect to each criterion, as follows (-1: Out of Scope, 0: Acceptable, 1: Suitable).

AAL Programme - "SAVE"

In the following section, it is presented as an example regarding the trade-off between eHealth Monitoring Services in terms of Online Health Service (OnHS) vs. eHealth Monitoring Services in terms of Offline Health Service (OffHS).

Table 9. Trade-off example based on The Pugh Concept Selection method.

Criteria	Weights	Solution 1 - eHealth Monitoring Services in terms of Online Health Service (OnHS)	Solution 2 - eHealth Monitoring Services in terms of Offline Health Service (OffHS)
1. SAVE project budget	3	0	1
2. SAVE project schedule	1	1	1
2. Technology Readiness	2	1	1
3. SAVE project proposal	3	1	1
Total		6	9
Accepted to be implemented		under specific conditions	Yes

Considering the fact that Solution 2 - eHealth Monitoring Services in terms of Offline Health Service (OffHS) plays a dominant role even in the nowadays healthcare European systems against the huge internet technological progress, the OffHS traditional services are about elders self-

AAL Programme - "SAVE"

biometric monitoring at-home through commercial off the shelf eHealth devices. This OffHS service category is a common solution, freely available, and (maybe) necessary to involve it in SAVE Project pilots by the entities conducting system pilots among end-users. To be defined.

On the other hand, besides end-users reluctance to technology, and the absence of telemedicine activities reimbursement, the developers in the consortium are eager to propose also Solution 1 - ehealth Monitoring Services in terms of Online Health Service (OnHS) to be implemented and deployed exclusively within 1 pilot (Romania) in order to be assessed by the end-users, but also by the business exploitation companies within SAVE consortium. Solution 1 - OnHS is enabled by the Internet and able to provide more financial convenience allowing elders to access ehealth services from everywhere.

3. Services Definition and Main Architectures

3.1.Services Definitions

The project consortium used an Agile method of development for the "co-creation" of services with maximum involvement of all categories of end-users and legal entities involved. For a future-proof system of services, the objective was to minimize the dependencies on particular technologies and equipment.

The main "SAVE" services are:

1) Location and orientation (The service can be used via an app on the smartphone: it is aimed to trace the routes taken outside the home and, in case of difficulty or disorientation, to locate the user and provide him/her with directions to return home and / or notify family members or personal assistants for help).

For these services we are using a smartwatch together with a smartphone in order to obtain accurate location and to use a public service for orientation. We tested this service with a Samsung Galaxy Watch and Samsung Galaxy S20 phone for demonstration but the watch and the phone can be chosen from another manufacturer also. These devices demonstrated the possibility of using this service with success. Both, the smartwatch and the smartphone, have GPS sensors and we can use „share location" for reporting or we can use existing apps like google maps or a dedicated app for orientation instructions.

3) SAVE project's main objective regarding eHealth sensors component is that it can offer eHealth at home monitoring for elderly people, over 50 years old, suffering from age-related chronic illnesses, mild cognitive issues/disabilities or cognitive decline. The service can be implemented as an Online Health Service (OnHS) and/or Offline Health Service (OffHS), both involving e-Health sensors used on-site at home. As settled at the level of technology, for complying with one of the main requirements of the European AAL perspectives in terms of interoperability and open interfaces for achieving a European market, the eHealth system concept is oriented towards Open-Source Hardware (OSHW) and COTS eHealth Platforms including COTS biosensors.

The eHealth system is based on the low-cost eHealth Platform from Libelium, namely MySignals Hardware (HW) Development Platform - eHealth and Medical IoT Development Platform for

AAL Programme - "SAVE"

Arduino. The eHealth system concept, comprises short- and long-range communication protocols as a Wi-Fi and Bluetooth4-enabled therefore scalable base station that offers two services:

- embedded C++ application: offers connection and readout of biometric sensors. It shares data with the cloud via a web service.

- web application: allows management and configuration for the base station. This option was considered better than OS-dependent smartphone app (iOS/Android). It will enable configuring the specific sensor, triggering a certain measurement, displaying the result of the measurement and setting the connection parameters used for cloud interaction, from any device connected to the same network as the base station (PC/laptop/smartphone).

4) Security (The service is uniquely capable to perform: alerts; technological training; bilateral services (push – pull, alert and ping). Thus, it offers both patient and supervisor the possibility to track the health history of the patient, storing automatically the monitoring results into a cloud system. It can be launched either by the person, but in some cases (e.g. loss of consciousness) it should be launched automatically. In an emergency case it is important to permit asking for urgent help in a simple way).

For this service we are using for testing a lot of sensors and devices. For sensors we tried a Xiaomi MI kit, but instead of working on smartphones, it can't be integrated with clouds and artificial intelligence so it's better to find other kits. For remote access in the situation of a non-responsive person inside, we tested a Yale Linus system that can be accessed by cloud and artificial intelligence. It seems to fulfill our goals and works also with Google and Alexa assistants. In tests, it opened the gate remotely and also locked the door automatically in order to protect the house. Also in bedtime routine it was inserted a line for locking the door before going to sleep. It is very useful because even the door is already locked, informing that for peace of mind.

5) Enhancing alert info – personal/domotic alert service (This service aims to contribute to the future of "Emergency calls" that should assist people at "both sides of the line" - not only end-users in need (that cannot open apps like Google Maps, not only because of cognitive impairment or lack of technical knowledge but even because of momentary extreme distress) but even volunteers or care-giving bodies operators that cannot interpret complex GIS - Geographical Information Systems – data).

We started using a smartwatch that can be used both with a smartphone and by itself. It can be personalized for an emergency app that will connect with the cloud.

6) Adapting physical exercise and social activities for elderly people, driven by voluntary organizations, regarding stress/cognitive assessment services, actigraphy based services and virtual trainer (Physical exercises for elders with support from volunteers. Adults aged 65 or older who are generally fit and have no health conditions that limit their mobility should try to be active daily. Examples of activities that require moderate effort for most people include: walking, ballroom and dancing, pushing different objects, playing table tennis (single, double). Muscle strength is necessary for: a) all daily movement; b) building and maintaining strong bones (improving their balance condition and their daily fit activities); c) maintaining a healthy weight). The smartwatch that we test will provide alerts and notifications from time to time in order to maintain an active life for the whole day. It tracks physical exercises and can provide small indications for simple movements.

Choice Reaction Time (CRT) methodology is based on a visual CRT based on several visual stimuli and two response buttons.

AAL Programme - "SAVE"

7) Personal (re-) planning service -" TO DO List" (The purpose of this service is to increase security, prevent social isolation, participate in various programs or occasional activities and maintain the multifunctional network around the individual. This tool will help in the planning and carrying out of the daily activity in a safer and more efficient way, also care implies social motivation and involvement. Through the "To do" section of the application, the elderly user will be helped to remember/update the planned activities, they will be informed about the following activities, synchronized in the "personal cloud" of their relatives, friends and formal caregivers). This service can be implemented on a smartphone with an app that will notify the smartwatch. In this simple manner we test that all items on the To do list are not ignored.

The smartwatch contains an embedded application written in C++ that connects to the Internet via Wi-Fi and can stream automatically data towards the cloud platform (PSRTC16), and receive notifications from it. The platform contains a http server, therefore is accessible from Android and iOS devices (PSRTC4: basically, from any device that has a web-browser application). In addition, the smartwatch contains standard applications, including one that allows answering incoming calls (PSRTC13) via its wi-fi interface.

The pilot evaluation of the first set of services is accomplished by elderly people selected through a system of questionnaires adapted for the Romanian, Italian and Hungarian partners, taking into account a number of cultural and educational differences (including a stricter approach to methods of collecting personal data in some countries).

3.2. Services Modeling

The co-design of SAVE services is based on the functional specifications agreed by the alleged users, respondents from the target groups from the three partner countries in the project. The functionalities were modeled into UML (Universal Modeling Language) *state diagrams* and the management of co-design activities was done with a set of software engineering methods based on a dedicated suite, "Visual Paradigm" that produced also class diagrams, usage contexts, state maps and activity diagrams.

To achieve this goal, we went through:

- Researching service modeling and creation environments, focusing on common tools currently used to create services;
- Choosing technologies, comparing their benefits and installing platforms and work environments (favoring open and free platforms / environments);
- Assessment of service creation methodologies on the chosen platforms - with case studies for the particular techniques;

UML promotes object-oriented modeling through syntactic rigor, rich semantics, support for visual modeling, etc. In practice, it has already been proven that the realization of quality diagrams contributes to a better understanding of both the solution and the modeled system. One of the important challenges in the process of modeling the behavior of a system is the management of complexity. There are conceptual reasons but also managerial reasons for which, in software

AAL Programme - "SAVE"

engineering, the systemic approach is practiced, with the necessary infusion of specific elements. Thus, at certain levels of abstraction of the UML solution of a problem, there are used the terms of systems, subsystems, models and diagrams that group these models according to principles and rules specific to different perspectives encountered in the solution architecture of a software system.

There are four more popular types of diagrams that can be used to model a software system.

- Class diagrams - These are diagrams that highlight the structural perspective of the system and cannot be missing from the object-oriented solution of a software product;
- Usage context diagrams - These are diagrams that organize the behavior of the system.
- Statue Map Diagrams - These are diagrams that focus on the state changes of an event-driven system.
- Activity charts - These are charts that focus on the flow of control in the process of moving from one activity to another.

Direct software engineering is the process of transforming a model into code, according to the language chosen for implementation, a transformation performed by a "utility" that "understands and interprets" UML modeling. Reverse engineering is the operation by which, starting from the code, we can obtain the associated UML model. Both operations aim to ensure a beneficial mapping of the UML solution of a problem, over the target implementation language solution and vice versa. The advantages are obvious, both in the case of direct engineering and in the case of reverse engineering.

Object-oriented modeling of SAVE services

In this section there are presented the steps followed for modeling UML services by making diagrams using the Visual Paradigm program.

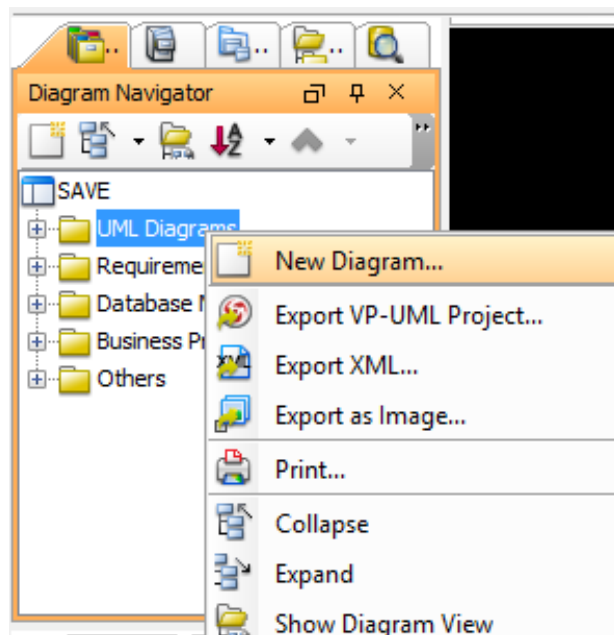

AAL Programme - "SAVE"

Figure 3. Choosing "New Diagram option"

For use case diagrams, they were followed the steps below:

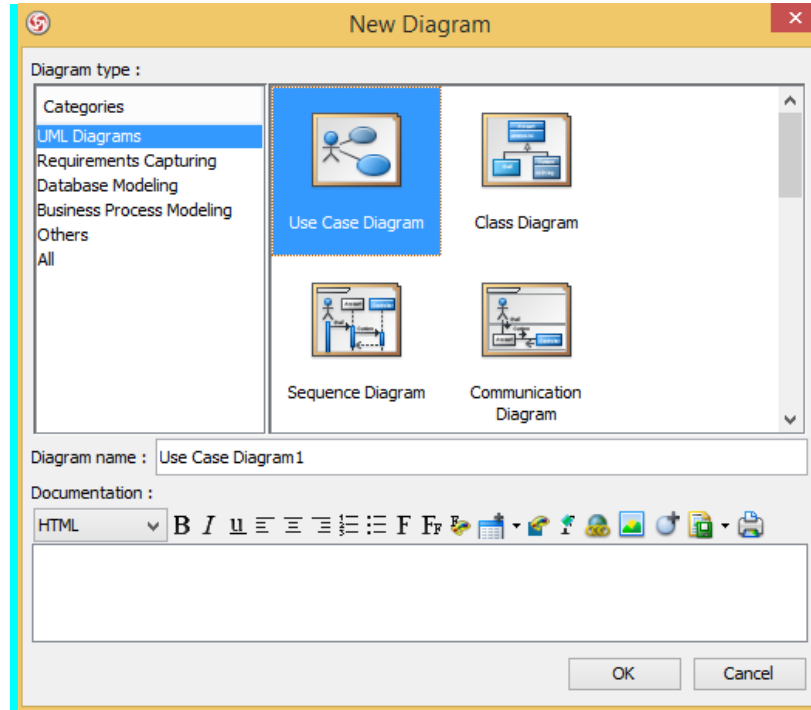

Figure 4. Selecting the option "Use Case Diagram"

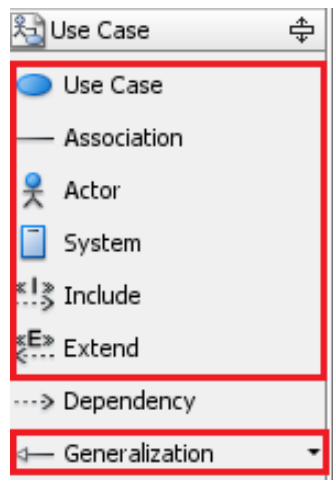

Figure 5. Choosing the tools for use case diagrams creation

The System tool was chosen - the created parts were placed and named;

AAL Programme - "SAVE"

The size of the diagram was extended, the actors and use contexts were placed and the same naming method as in the previous paragraph was applied;

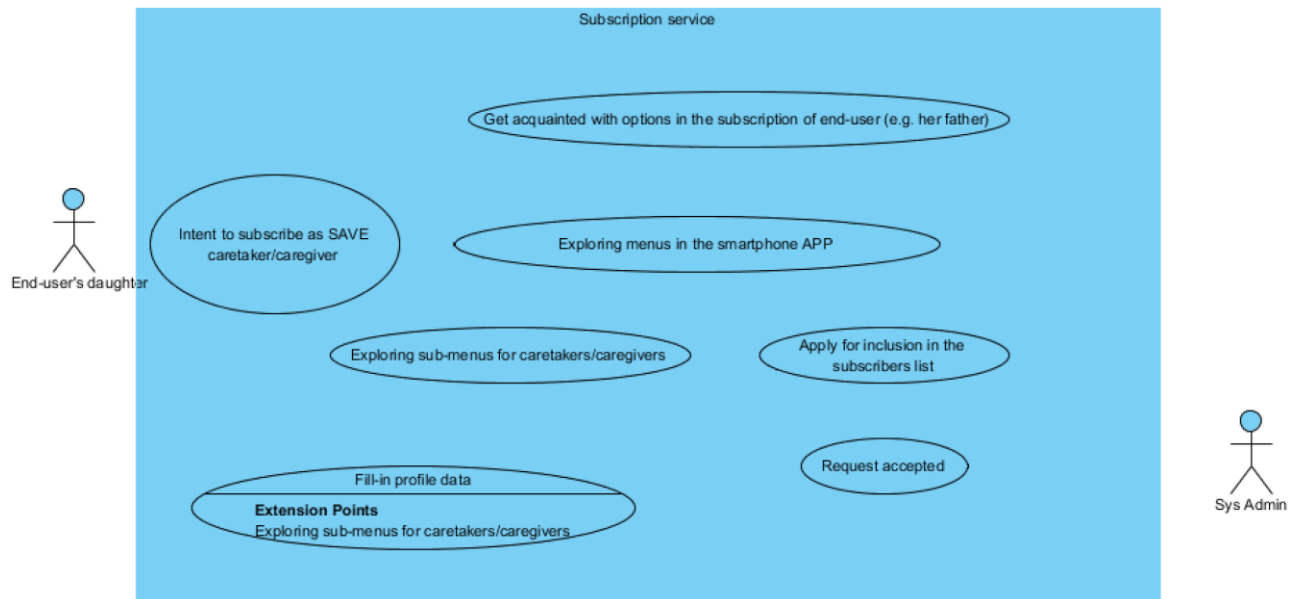

Figure 6. Placing actors and usage contexts within the system

Once all the necessary elements have been placed, they can be created the links between those items using the Association, Include, Extend, and Generalization tools, obtaining a diagram of the usage contexts that can be seen as a scenario in which the Subscription service can be applied.

That chart can be seen in the image below.

AAL Programme - "SAVE"

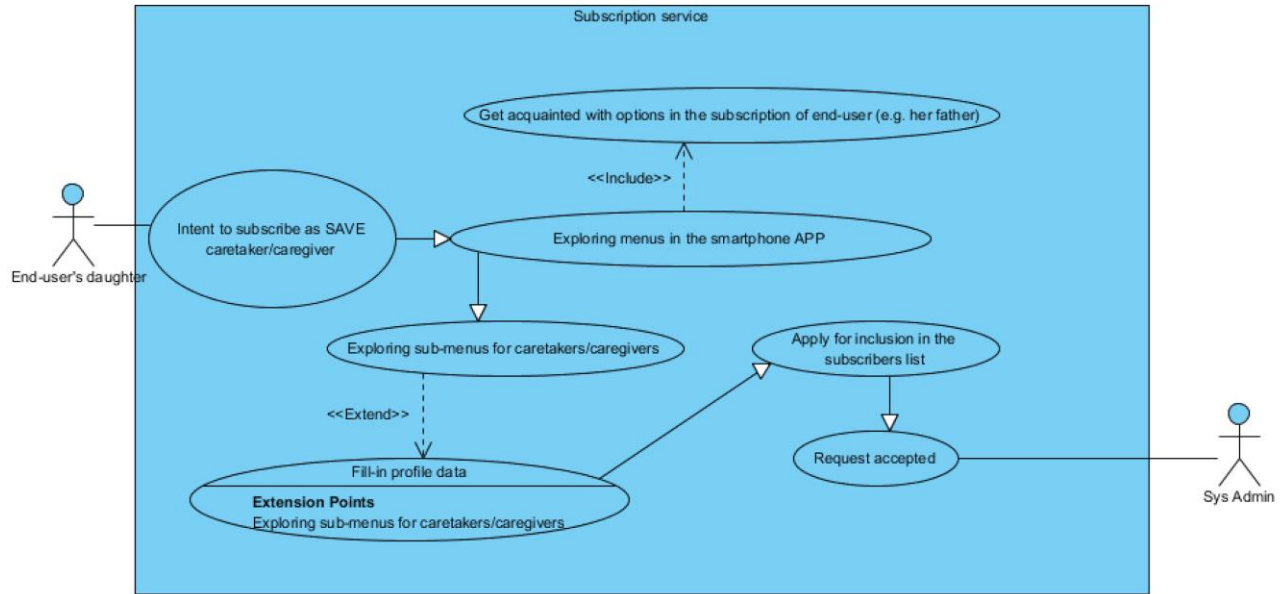

Figure 7. Use case diagram finalized for the "Subscription" service

Below it can be seen another use case diagram for the " Safety" Service .

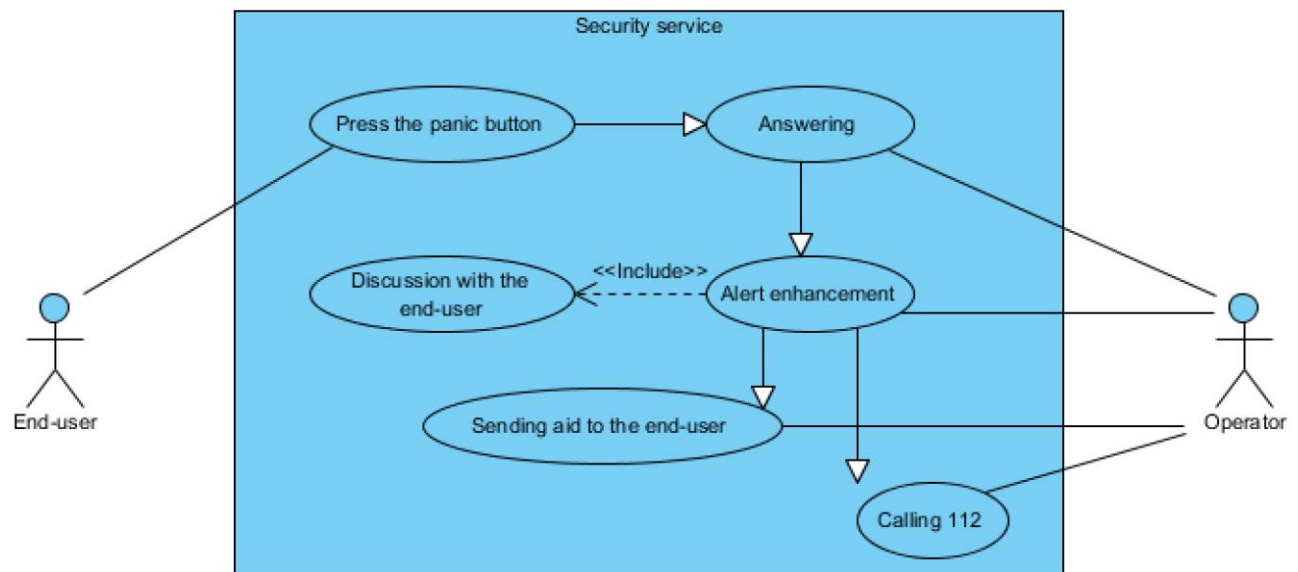

Figure 8. Use case diagram for the " Safety" Service

A mention can be made here in relation to the making of these types of diagrams, namely, that when creating an *Extend* relationship between two contexts in the system, the context

AAL Programme - "SAVE"

representing the extension of the other must have an imposed condition. For the previous example, a person who wants to subscribe must necessarily fill in all the necessary profile information.

The other use case diagrams are:

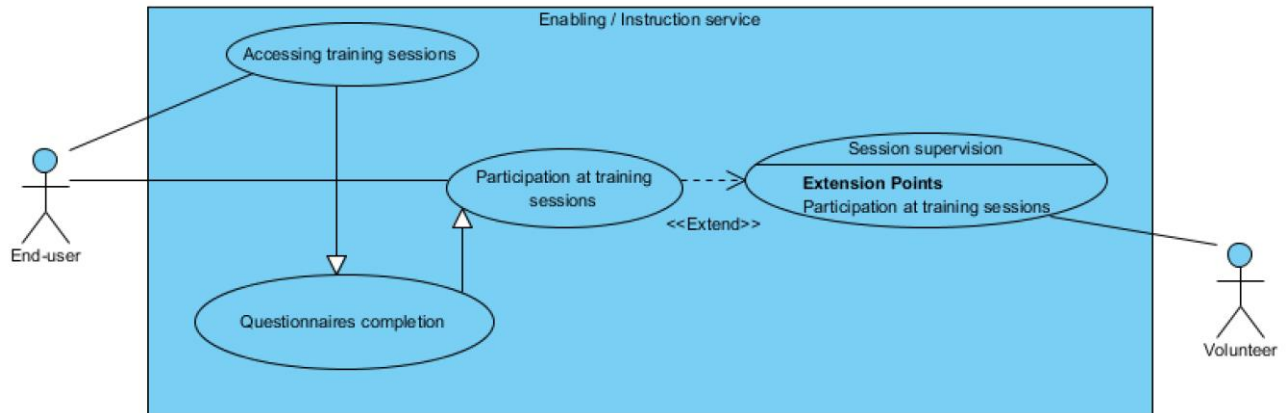

Figure 9. Use case diagram for the "Enabling / Instruction" service

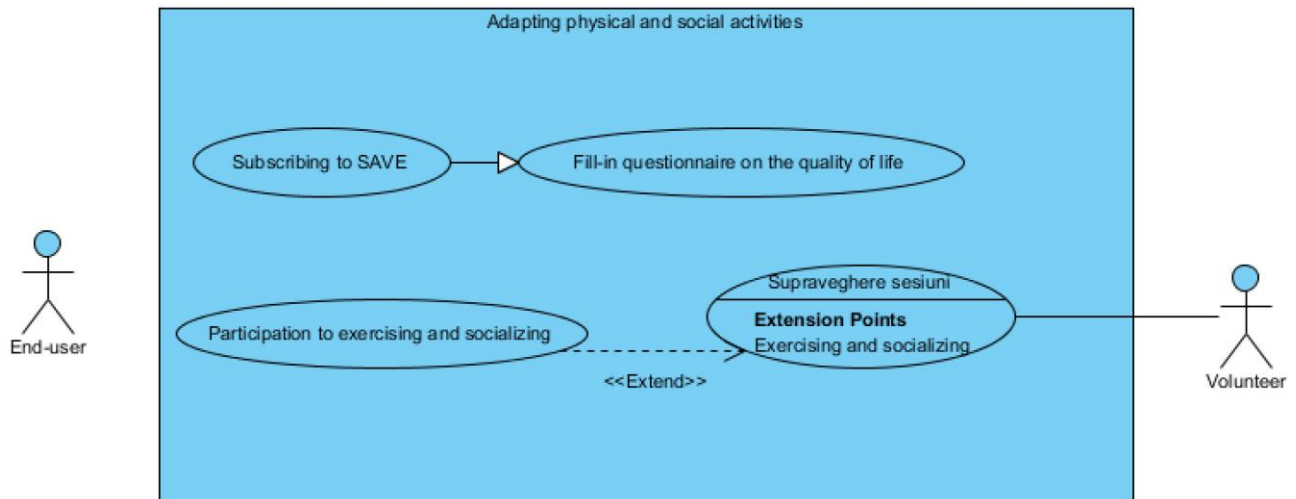

Figure 10. Use case diagram for the "Adapting physical and social activities" service

AAL Programme - "SAVE"

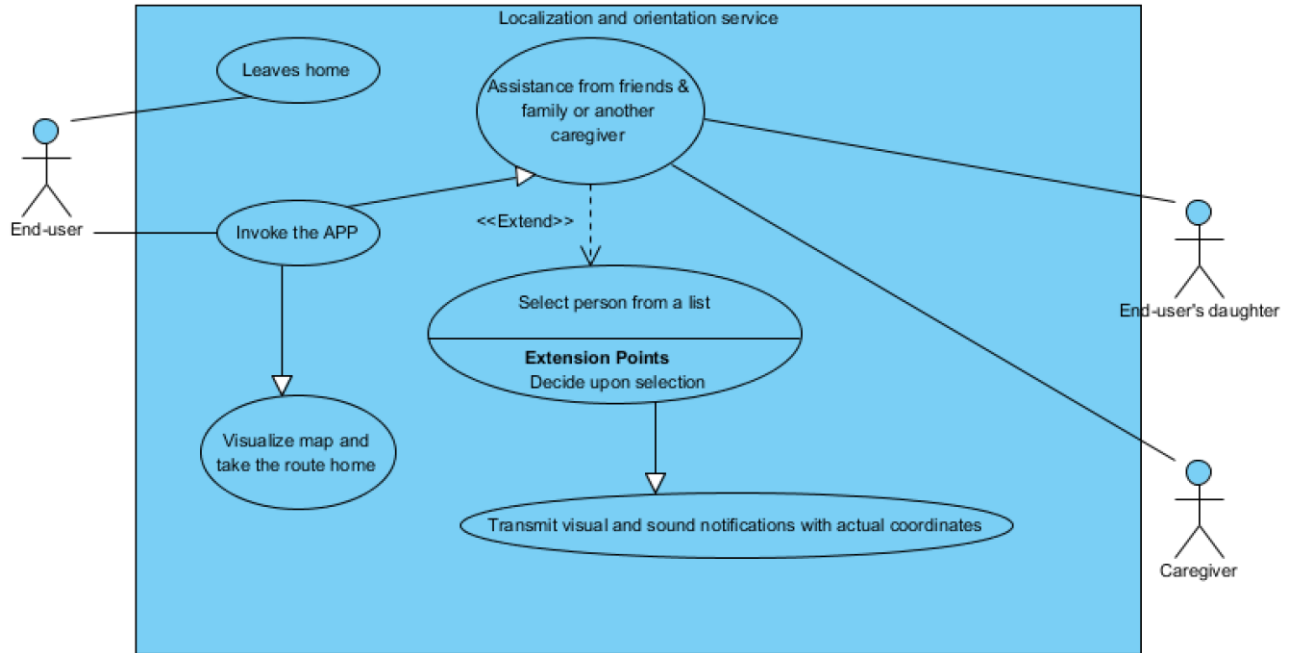

Figure 11. Use case diagram for the "Localization and orientation" service

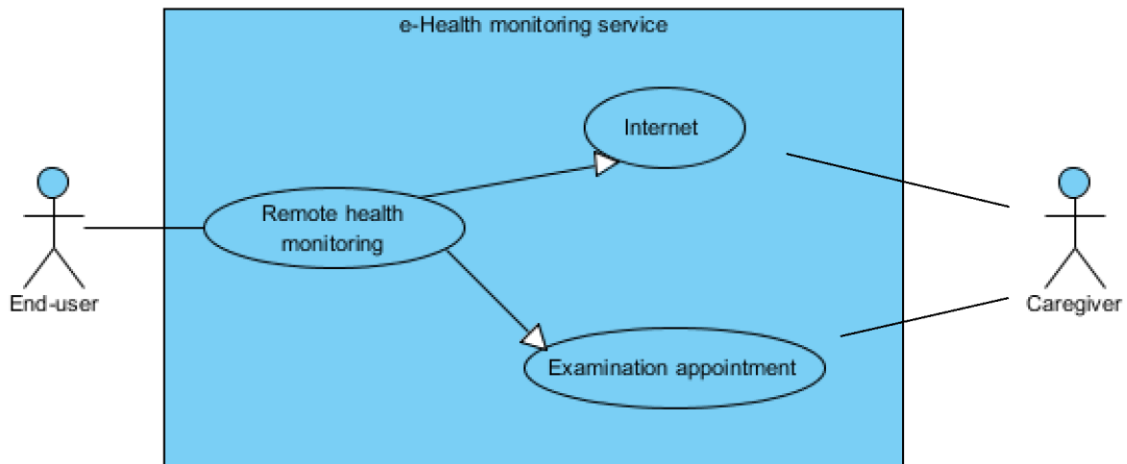

Figure 12. Use case diagram for the "e-Health monitoring" service

AAL Programme - "SAVE"

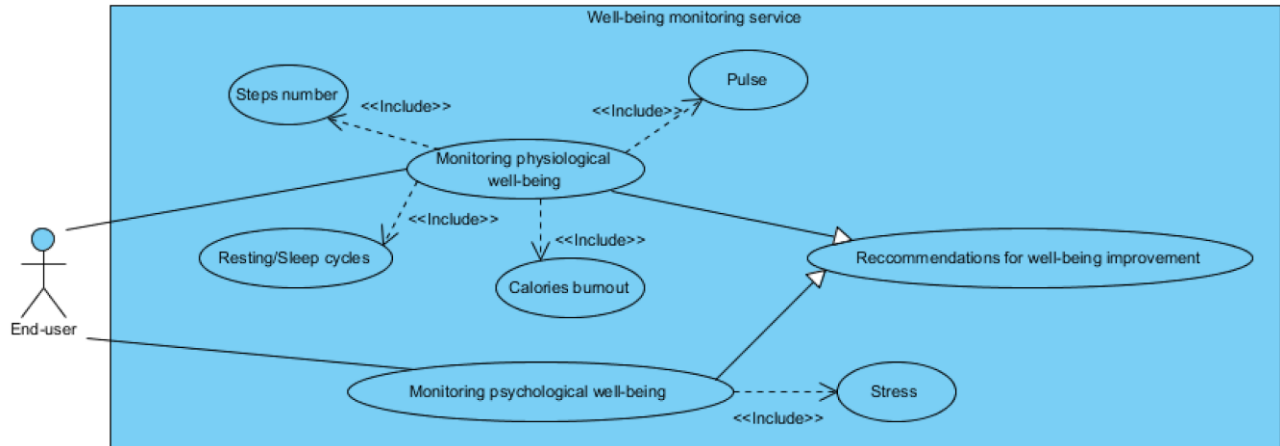

Figure 13. Use case diagram for the "Well-being monitoring" service

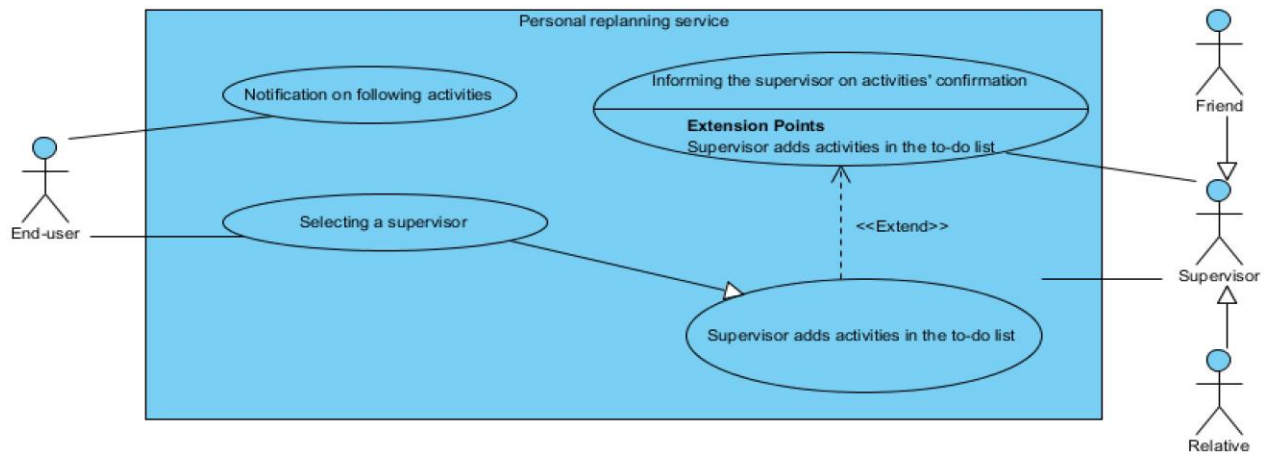

Figure 14. Use case diagram for the "Personal replanning" service

AAL Programme - "SAVE"

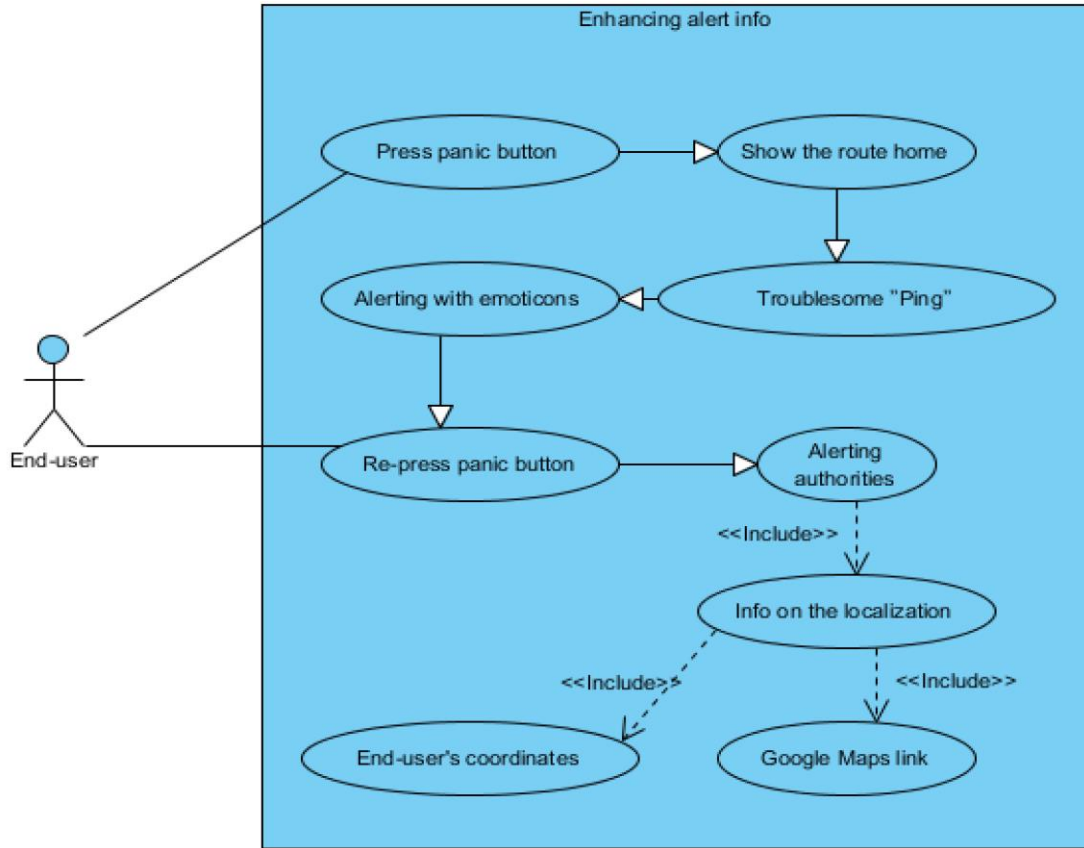

Figure 15. Use case diagram for the "Enhancing alert info" service

For the State machine diagrams, the steps are the following:

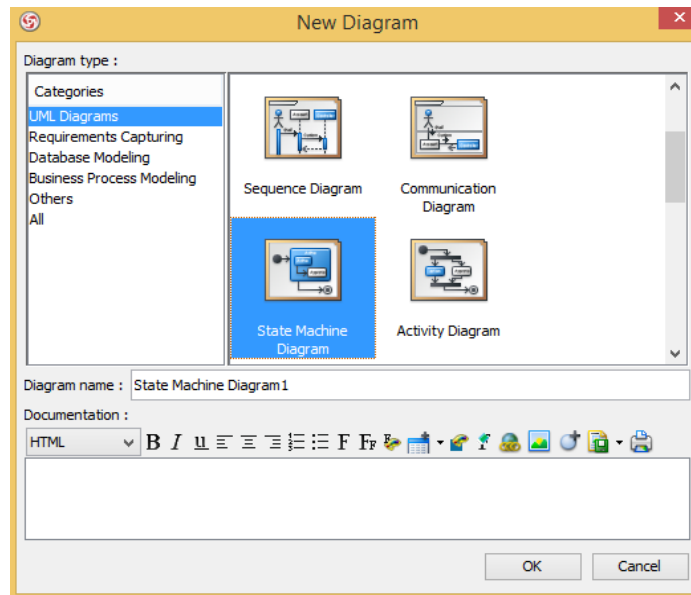

Figure 16. Selecting the option "State Machine Diagram"

AAL Programme - "SAVE"

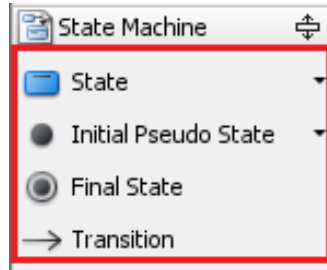

Figure 17. Choosing the tools for the "State Machine Diagram" creation (a)

Another aspect related to the choice of tools to represent these charts is the fact that the Initial Pseudo State tool contains a list of items that were used to make the diagram and that can be viewed in the following image.

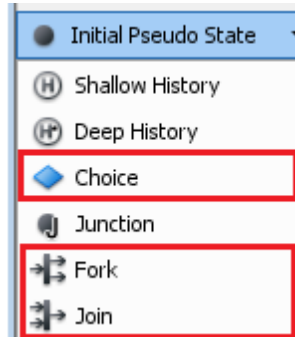

Figure 18. Choosing the tools for the "State Machine Diagram" creation (b)

Choosing the State tool, placing it and naming the state to be created; Placing all the elements necessary for the diagram and applying the same naming method as in the previous paragraph; After the placement process, one can create the links between those items using the Transition tool, and it is obtained a chart that illustrates the dynamic behavior of the "Alerting" service. The diagram can be viewed in the following image.

AAL Programme - "SAVE"

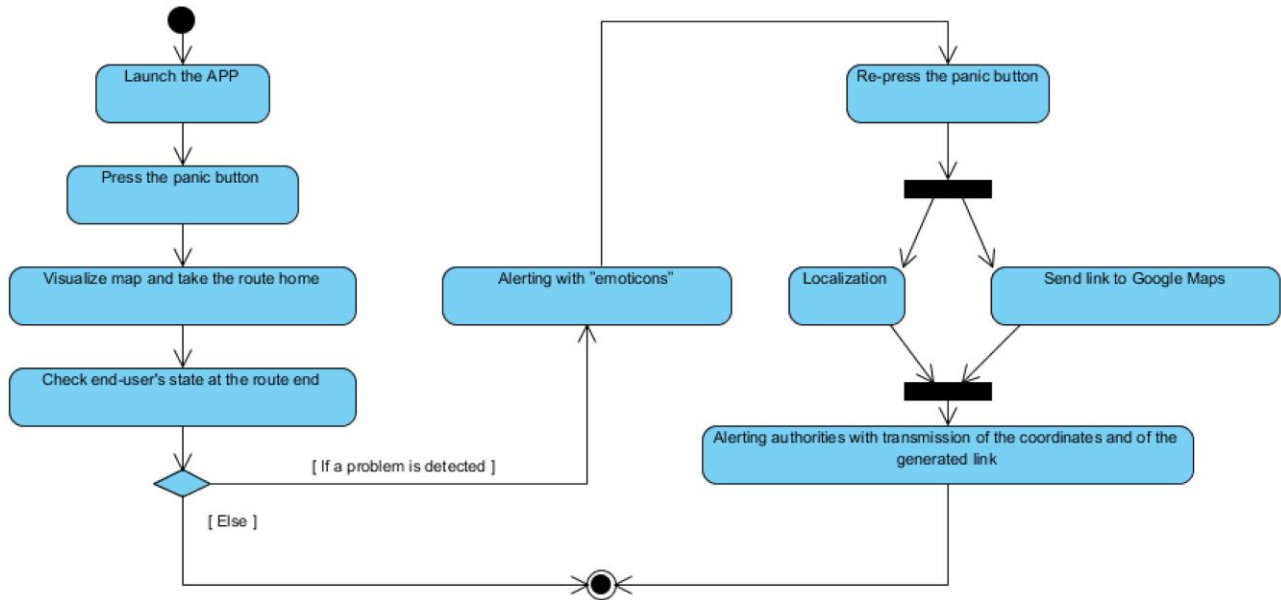

Figure 19. State Machine Diagram for the "Alerting" service

3.3. Integrated services architecture

Services integration into the SAVE general Architecture is presented in the following figure:

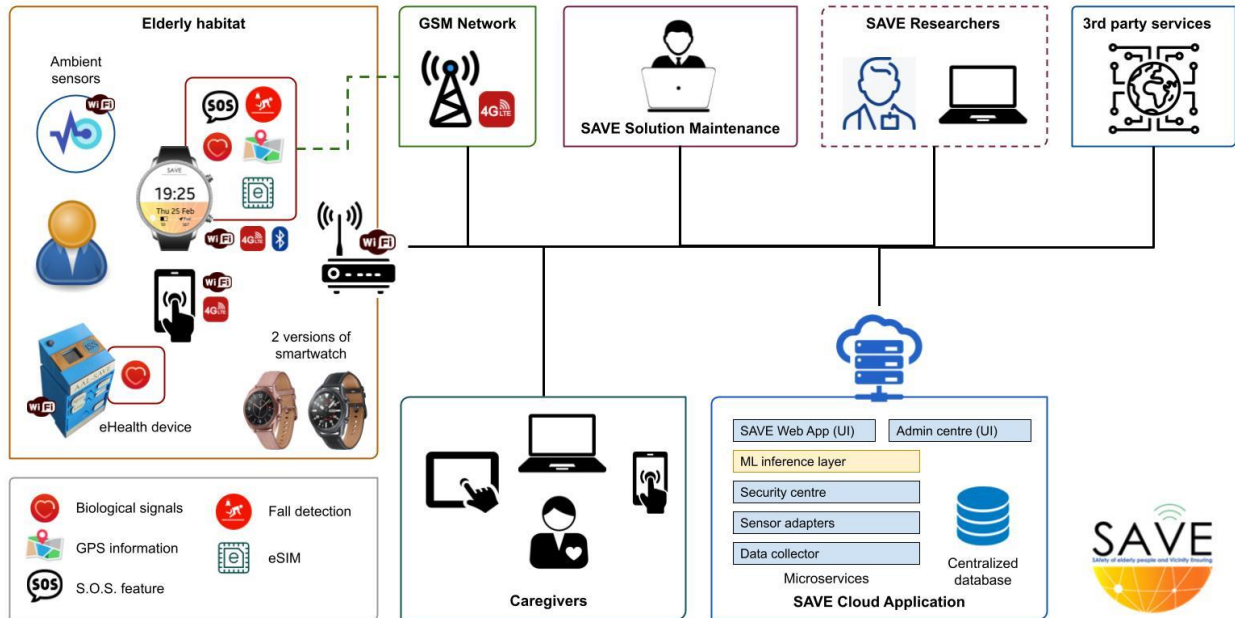

Figure 20. SAVE general architecture

AAL Programme - "SAVE"

As an example is the **Well-being Service** (physical and social activities adaptation). (CRT Cognitive assessment service via Choice Reaction Time) measurement methodology and sensor implementation is shown in the following figure:

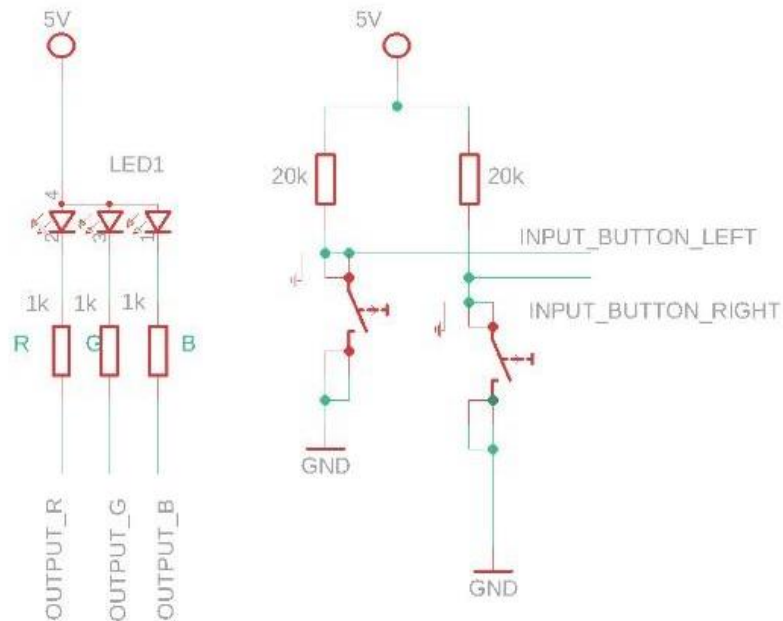

Figure 21. CRT sensor electrical schematic. Figure source: Institute of Space Science

The CRT sensor encompasses two tactile switches together with one 5mm RGB-LED. The LED segments are CA (common anode) and the current through them is limited by the 1kOhm resistors. The tactile switches put the microcontroller's inputs to ground whenever they are pressed. The microcontroller's switch inputs have the weak pull-up enabled.

AAL Programme - "SAVE"

Another example is the **eHealth Monitoring Service**

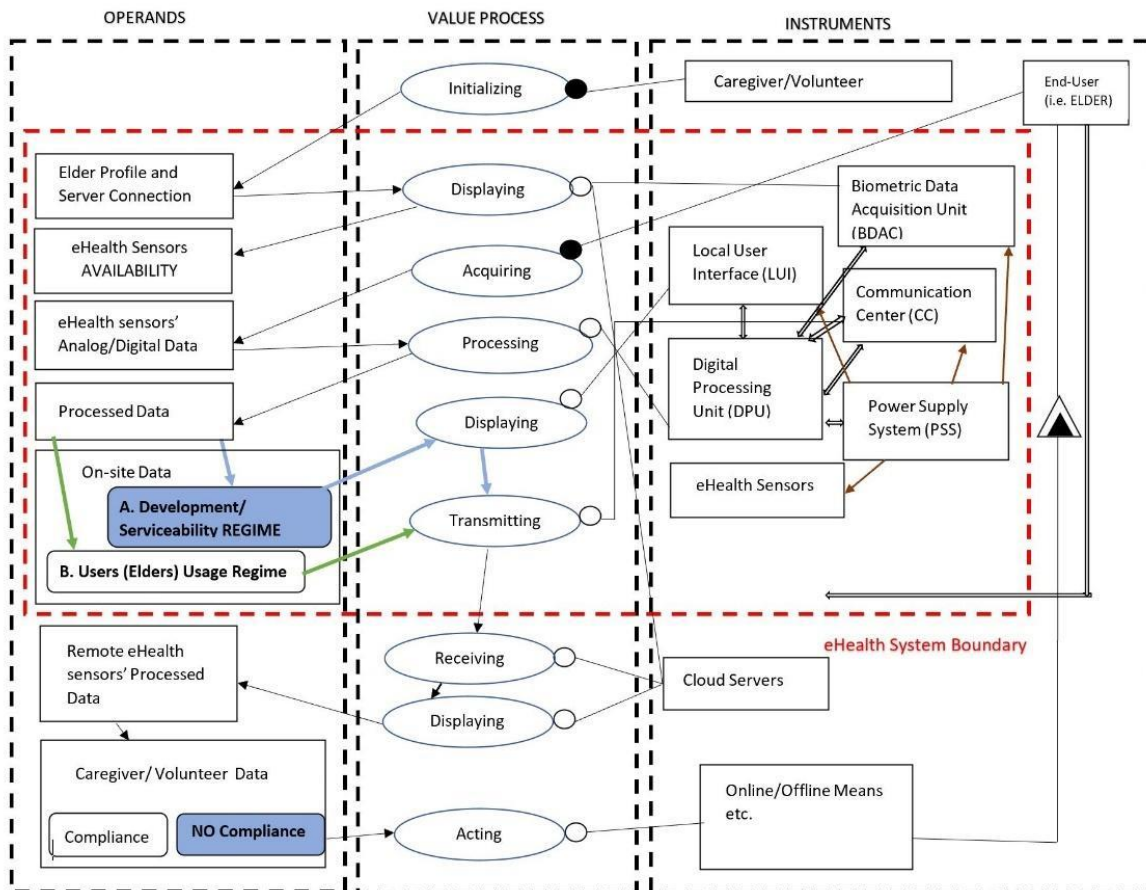

Figure 22. eHealth system architecture in the form of Object-Process Diagram (OPD).

Figure source: Institute of Space Science

The eHealth desired objectives consists in automatically collecting biometric data (e.g., unique physiological, physical, behavioral data) from elders on site and further transmitting the data to caregivers/volunteers for achieving the proper communication value chain.

According to OPD in the figure, there are two regimes of user interface functionality that may emerge in parallel, as follows:

- Regime of system development and serviceability, the biometric data is displayed on site and further transmitted via the internet, exclusively for the developers.
- Regime of daily usage by the elders, the biometric sensor data is not displayed on site, but transmitted exclusively via internet to caregivers/volunteers outside the eHealth system boundary.

AAL Programme - "SAVE"

References

- [1] Tan, J. (Ed.), 2010. *Developments in Healthcare Information Systems and Technologies: Models and Methods: Models and Methods*. IGI Global.
- [2] Vasilakis, C., Leczarowicz, D., & Lee, C., 2008. Application of unified modelling language (UML) to the modelling of health care systems: an introduction and literature survey. *International Journal of Healthcare Information Systems and Informatics (IJHISI)*, 3(4), 39-52.